

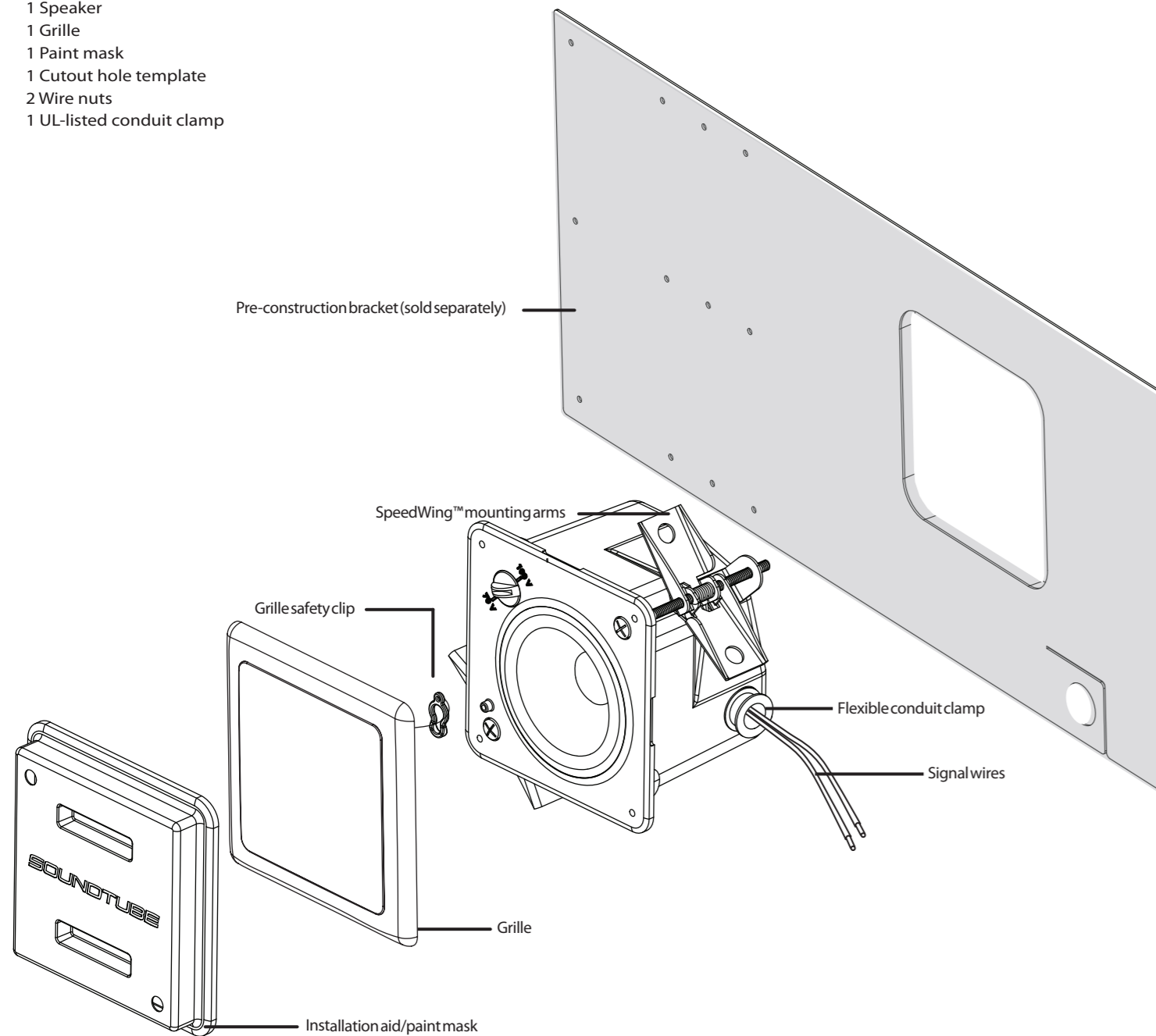

IW31-EZ | Install Instructions For:
IW31-EZ speaker

Box contents

- 1 Speaker
- 1 Grille
- 1 Paint mask
- 1 Cutout hole template
- 2 Wire nuts
- 1 UL-listed conduit clamp



©2011 SoundTube Entertainment, Inc. All rights reserved. PN INS-IW31-EZ Rev09.12.11

Warning
SoundTube speakers must be installed by a professional audio installer/contractor. For safety and for optimum audio performance, installer must follow all directions issued by SoundTube Entertainment.

Warning
Do not spec or install speaker near support beam, ventilation duct or other structure that may interfere with speaker function or dispersion.

IW31-EZ | Installation Instructions For:
IW31-EZ speaker

1.435.647.9555 | 800.647.TUBE | www.soundtube.com

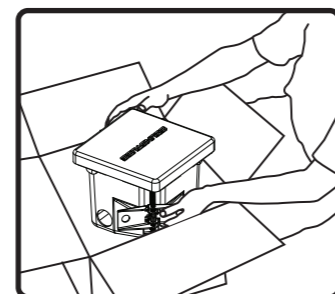

1. Unpack speaker. Leave paint mask in place until after speaker is installed or painting is complete.

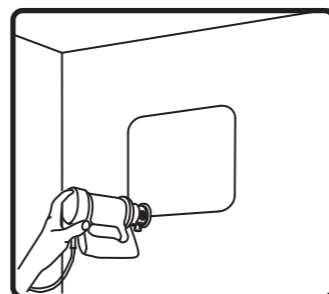

2. Use provided cutout template to mark hole. Use RotoZip or other tool to cut hole in wall. Hole size: 4.25 in. (108 mm) tall x 4.25 in. (108 mm) wide.

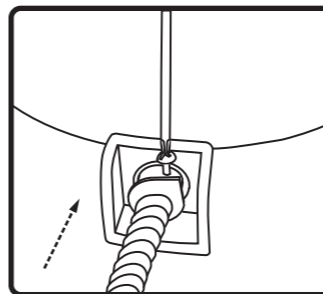

3. Feed speaker wires through conduit clamp and connect with wire nuts. Push wire nuts into backcan and affix conduit clamp.

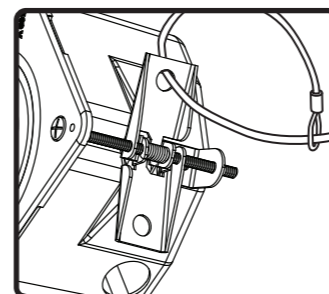

4. If required, attach seismic restraint system to the hole in the metal clamping arm, then to reinforced structure (safety cable not included).

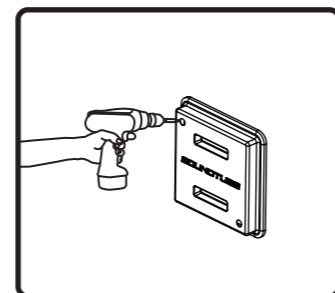

5. Insert speaker in hole. Tighten the two clamping screws. **DO NOT OVERTIGHTEN**.

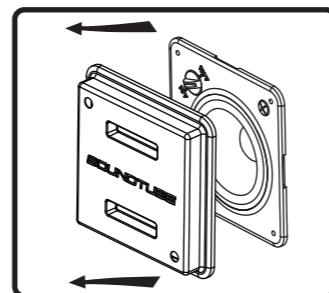

6. Remove paint mask unless painting is required. In that case, follow steps 7-10 when painting is complete.

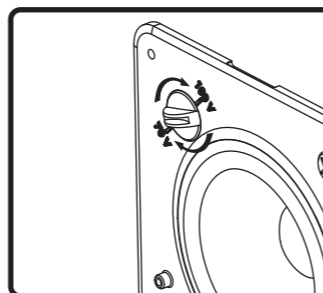

7. Adjust tap switch to proper setting. Switch is preset to the highest setting in the 70.7-volt mode.

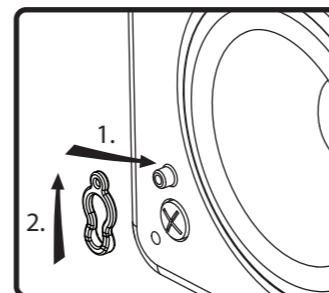

8. Attach grille safety clip by placing the large end of the clip over snap-fit post (1), then sliding clip until small end snaps into place around post (2).

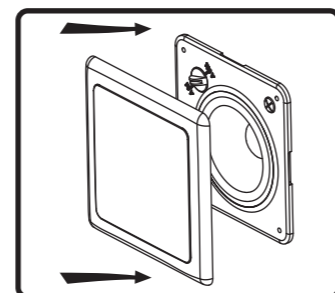

9. Align tabs on snap-fit grille with slots in baffle, gently press grille into place.

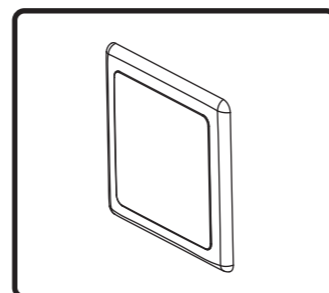

10. Done!

IW31-EZ | Pre-Construction Bracket Instructions For:
IW31-EZ speaker

1.435.647.9555 | 800.647.TUBE | www.soundtube.com

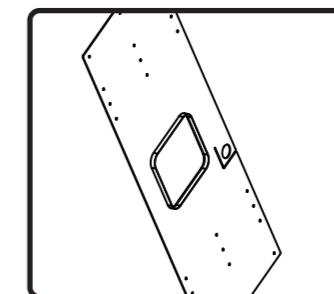

1. Nail or screw bracket to studs.

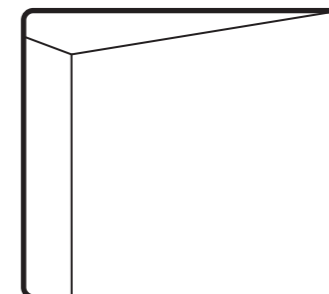

2. Finish installing wall.

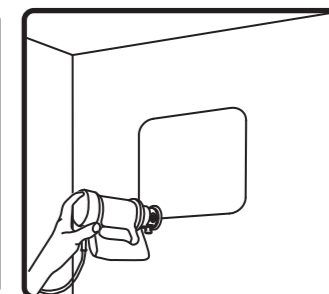

3. Use RotoZip or other tool to cut hole.

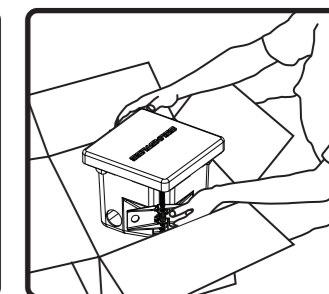

4. Unpack speaker. Leave paint mask in place until after speaker is installed or painting is complete.

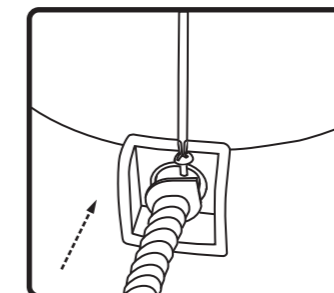

5. Feed speaker wires through conduit clamp and connect with wire nuts. Push wire nuts into backcan and affix conduit clamp.

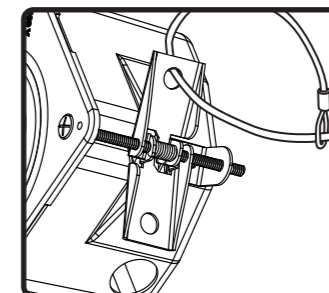

6. If required, attach seismic restraint system to the hole in the metal clamping arm, then to reinforced structure (safety cable not included).

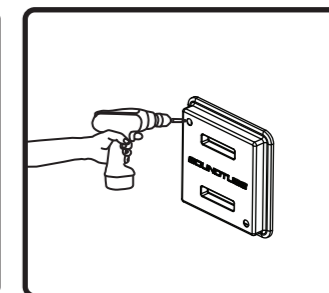

7. Insert speaker in hole. Tighten the two clamping screws. **DO NOT OVERTIGHTEN**.

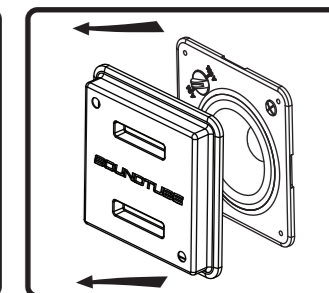

8. Remove paint mask unless painting is required. In that case, follow steps 9-12 when painting is complete.

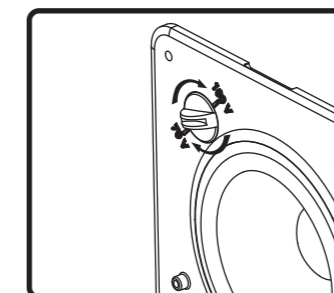

9. Adjust tap switch to proper setting. Switch is preset to the highest setting in the 70.7-volt mode.

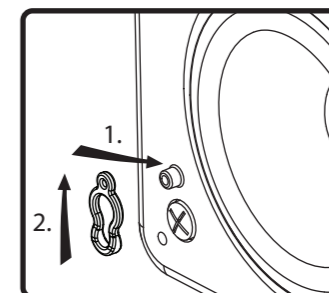

10. Attach grille safety clip by placing the large end of the clip over snap-fit post (1), then sliding clip until small end snaps into place around post (2).

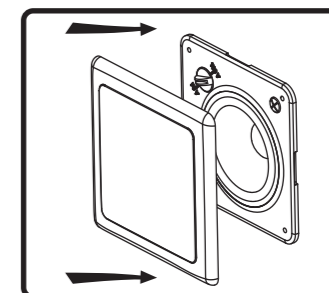

11. Align tabs on snap-fit grille with slots in baffle, gently press grille into place.

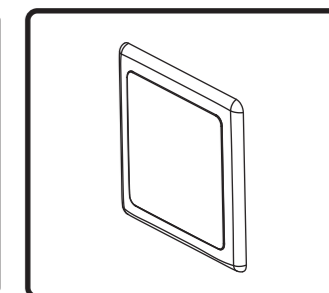

12. Done!

Warning
SoundTube speakers must be installed by a professional audio installer/contractor. For safety and for optimum audio performance, installer must follow all directions issued by SoundTube Entertainment.

Warning
Do not spec or install speaker near support beam, ventilation duct or other structure that may interfere with speaker function or dispersion.